



---

Modern  
Electric  
Fireplaces

---

3

# Contents

|                     |            |
|---------------------|------------|
| Configuration Guide | Page 3     |
| Vermont             | Page 4-5   |
| Atlanta             | Page 6     |
| Maine               | Page 6-7   |
| Dakota              | Page 8     |
| Nevada              | Page 8-9   |
| Texas               | Page 10-11 |
| Florida             | Page 11    |
| Kentucky            | Page 12    |
| Kansas              | Page 13    |
| Georgia             | Page 14    |
| Montana             | Page 14-15 |
| Missouri            | Page 16    |
| Oregon              | Page 17    |
| Shelves             | Page 18    |
| Ripon               | Page 19    |
| Colour Guide        | Page 20    |

## Fireplaces to enhance most models of Electric fire.

At Focus, we have been manufacturing a range of attractive fireplaces to complement the Gazco eReflex fires since they were first launched. Working in conjunction with the fire manufacturers, we are now introducing some fabulous new designs that combine with the latest ranges of electric fires from Gazco, Onyx and British Fires.

What's more – most of these designs can easily be adapted to suit fires from many other manufacturers including Charlton & Jenrick and Evonic Fires.

With floor-standing and wall-hanging fireplace choices and a wide variety of painted, veneered or solid oak finishes available, there is something to suit all styles and tastes.

For a flexible approach to creating the perfect fireplace to suit your interior décor scheme - you can simply review our range of fireplaces, select your favourite based on one of our existing designs and discuss any specific requirements with your stockist.

Check out our website for more details [www.focusfireplaces.co.uk](http://www.focusfireplaces.co.uk)

The Oregon with Top Shelf and Base in Oak Veneer with a Grey Pearl Deep Plinth



# A Guide to our Modern Electric Fireplaces

Our fireplace designs are made up from separate components. The guide below illustrates the wide range of designs available that can be utilised to create your perfect fireplace. Add in the extensive choice of dimensions, materials, colours and finishes and you will be certain to find the combination that is right for you! Any bespoke alterations are subject to the dimensions of the fire itself. Please refer to the back cover of the brochure for more details of the finishes available.

## Designs examples:

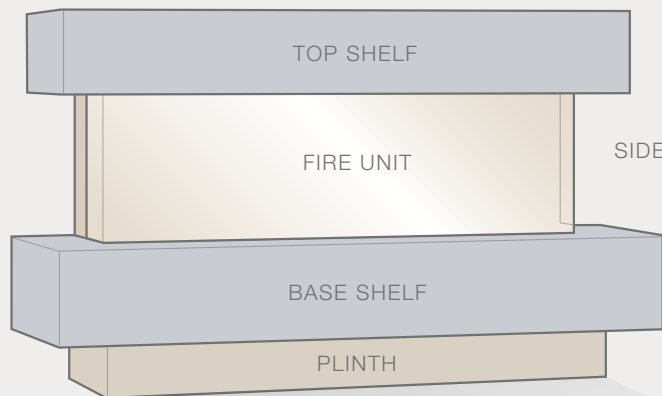

Designs: Nevada, Dakota

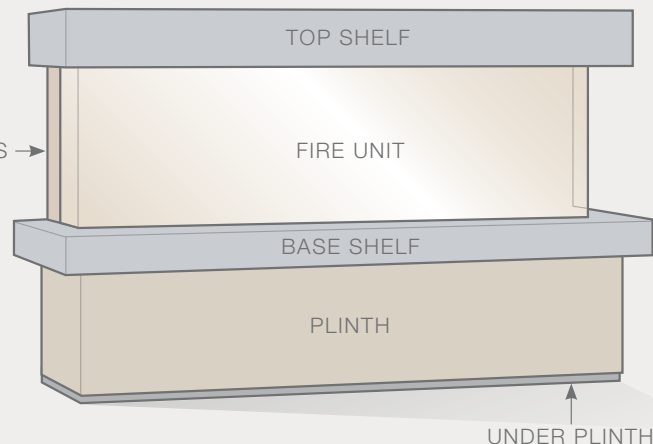

Design: Oregon

|   |  |
|---|--|
| 1. TOP SHELF                                      | The height of the top shelf may be dictated by the fire itself   |
| 2. FIRE UNIT<br><i>(with/without SIDE CHEEKS)</i> | Side cheeks can be added to match the other elements of the fireplace  |
| 3. BASE SHELF                                     | Subject to your choice of fire, it is usually possible to adjust the dimensions of the base shelf, the plinth and the under-plinth |
| 4. PLINTH   |  |
| 5. UNDER PLINTH                                   |  |
| ADDITIONAL OPTIONS:                               |  |
| A. Oak Finished Strips (see page 17)              |  |
| B. Lighting Kits (see pages 4 and 5)              |  |

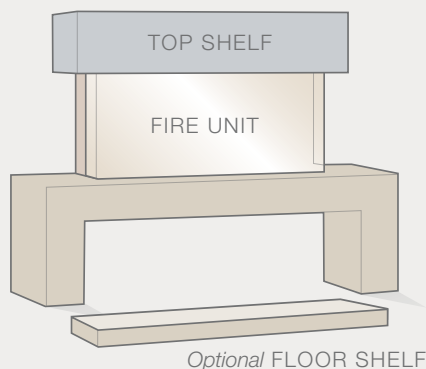

Designs: Maine, Missouri, Atlanta

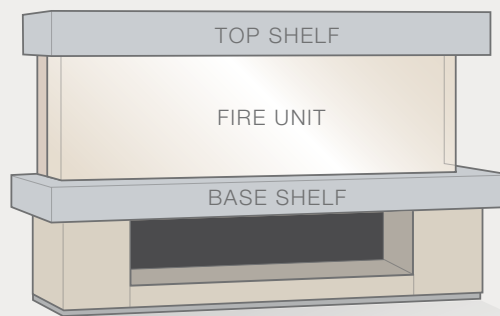

Designs: Montana, Georgia

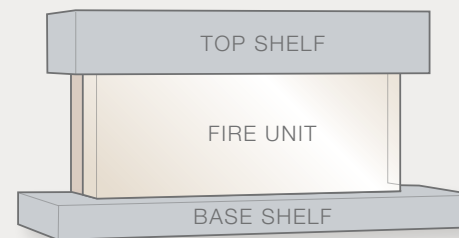

Designs: Texas, Florida

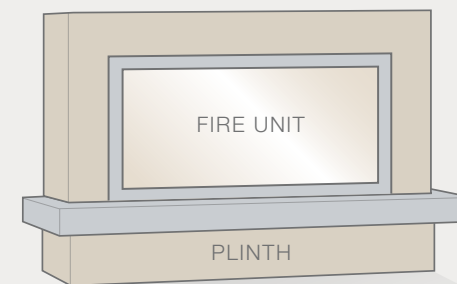

Design: Vermont



Vermont 85 in Warm Grey and Slate Finish



Vermont 105 in White and Light Oak Finish



Vermont 105 in Bianca and Midnight Finish with Optional Lighting

# Vermont

*illustrated with the Gazco eStudio fire*

The elegant Vermont Fireplace is a real design statement.

Created to house the eStudio 85R and 105R fires, the Vermont can be installed as either a wall-hanging or floor-standing fireplace. With optional LED lights and available in a range of attractive finishes, the Vermont will set the mood of your living room.

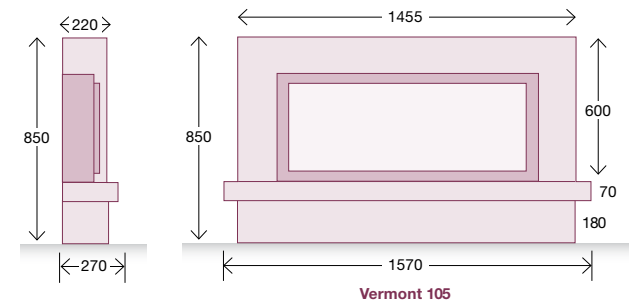
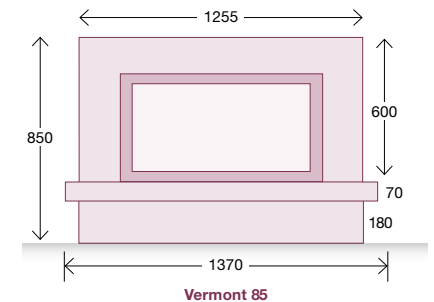



# Atlanta *illustrated with the British Fires New Forest fire*



Atlanta Base Unit in White and Midnight Finish

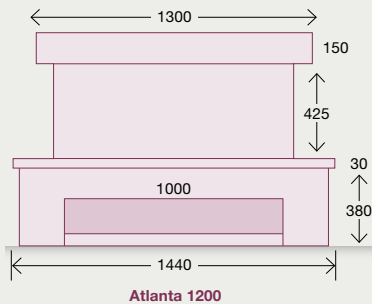

Dimensions dependant on fire selected.



Maine 70 Base Unit and Top Shelf in Grey Pearl

# Maine *illustrated with the Gazco eReflex fire*

The Maine fireplace is tremendously versatile. Two basic sizes are available to match either the 70w fire or the 110w fire and both of these fireplaces can be altered in size to suit your particular requirements or alternative fires.

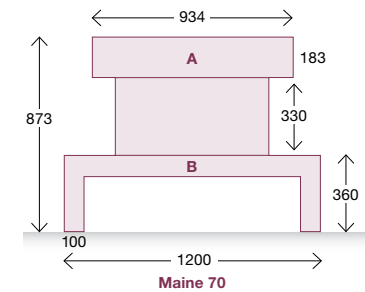
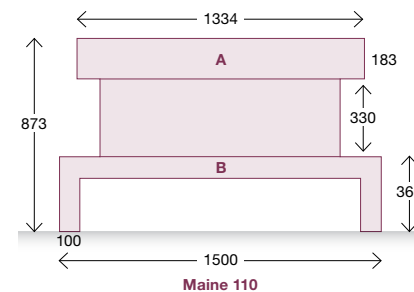

Both A and B are 300mm deep (from wall to front of unit)





Nevada Base Unit in White and Midnight with Top Shelf in White Finish

# Nevada

*illustrated with the Gazco eReflex fire*

The floor-standing Nevada fireplace is designed to suit the 70w and 110w eReflex fires. It can also be adapted to suit a wide variety of fires from other manufacturers. See the back page for all the finishes that are available.

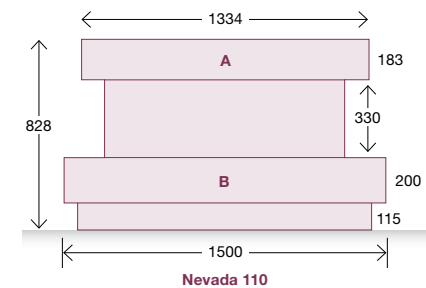

Both **A** and **B** are 300mm deep (from wall to front of unit)

# Dakota

*illustrated with the British Fires New Forest fire*

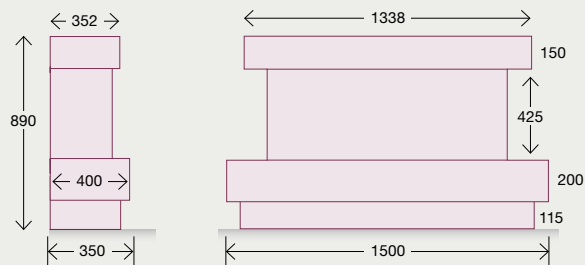

*Dimensions dependant on fire selected.*









All the designs in this catalogue can be altered to suit your individual requirements. This illustration shows how the Texas fireplace has been made longer on the right-hand side to provide some extra display space.

# Florida

illustrated with the British Fires New Forest fire

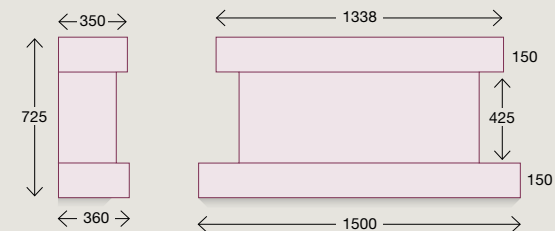

**Florida 1200**

Dimensions dependant on fire selected.

Florida Base Unit in Light Oak Finish with Top Shelf in White



Texas 70 Base Unit in White

# Texas

illustrated with the Gazco eReflex fire



Texas 70 Base Unit and Top Shelf: Rustic Oak in a Medium Finish

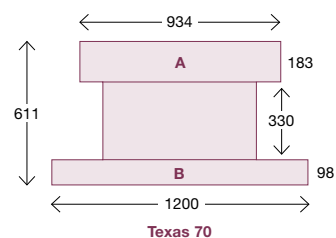

**Texas 70**

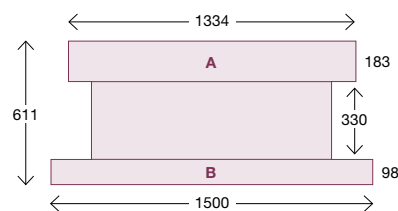

**Texas 110**

Both **A** and **B** are 300mm deep (from wall to front of unit)





Kentucky 70 Base Unit: Aged Oak in a Medium Finish

Kentucky 70 Base Unit and Top Shelf in Grey Washed Oak Finish



Kentucky 110 Base Unit in White Finish



# Kentucky

*illustrated with the Gazco eReflex fire*

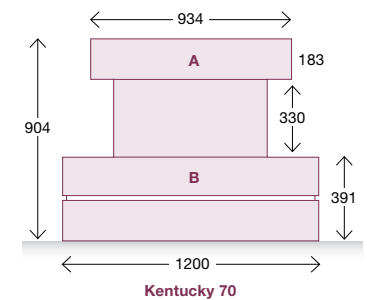
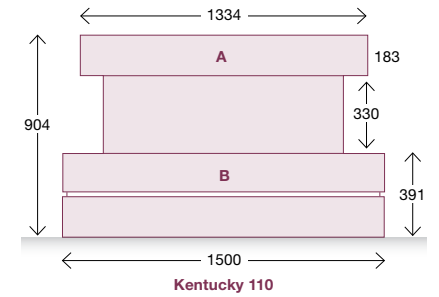

Both A and B are 300mm deep (from wall to front of unit)



Kansas 70 Base Unit in Grey Washed Oak Finish with Top Shelf in White Finish

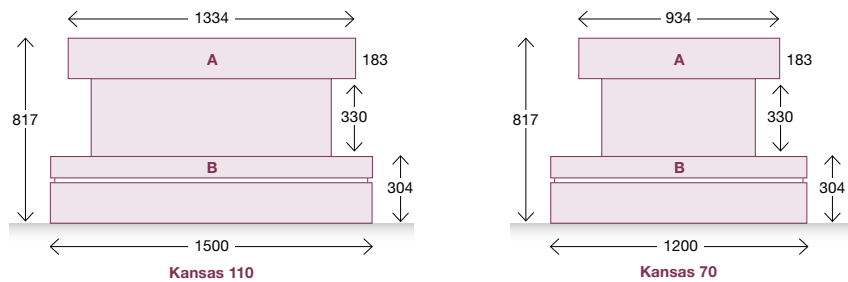

Both A and B are 300mm deep (from wall to front of unit)

Dimensions dependant on fire selected.

# Kansas *illustrated with the Gazco eReflex fire*

The Kansas and Kentucky fireplaces offer an almost limitless number of options. They look stunning with either with a Top Shelf or a Chimney Breast. The back page of this brochure shows all the different choices of timber finishes and painted finishes that these fireplaces can be produced in.

Kansas 70 Base Unit and Top Shelf: Rustic Oak in a Light/Medium Finish



# Georgia

illustrated with the British Fires New Forest fire

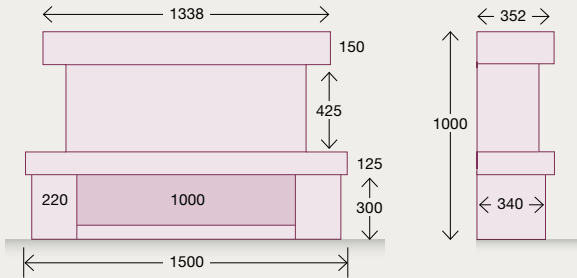

Georgia 1200

Dimensions dependant on fire selected.



# Montana

illustrated with the Gazco eReflex fire



Montana 110 Base Unit in Bianca and Midnight Finish Top Shelf in Bianca Finish

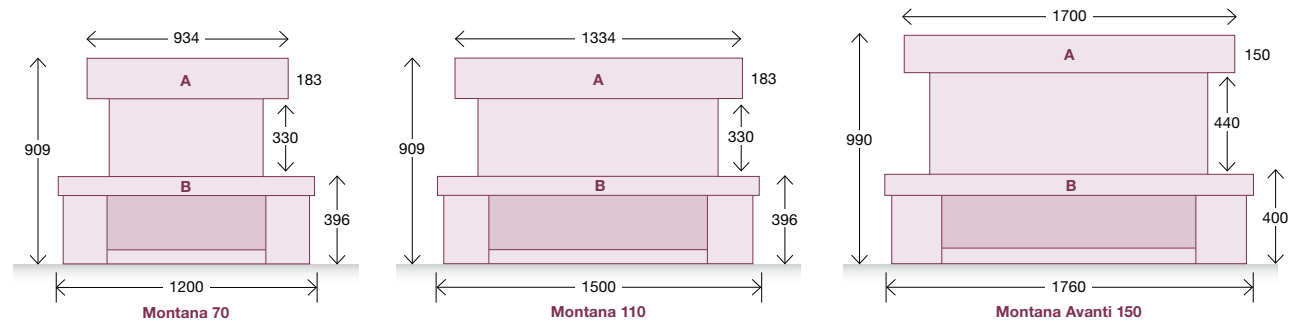

Both A and B are 300mm deep (from wall to front of unit)

Dimensions dependant on fire selected.

A 380mm and B 400mm deep (from wall to front of unit)



Montana Avanti 150 in Soft Cream and Light Oak Finish - illustrated with the Onyx Avanti 150 fire



Missouri 110 Base Unit in White and Midnight Finish  
Top Shelf in White Finish

# Missouri

*illustrated with the Gazco eReflex fire*

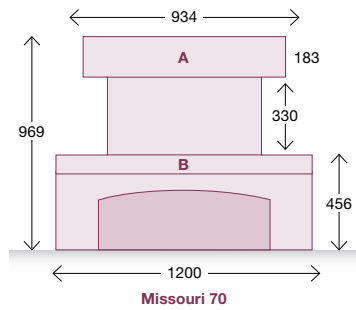

Missouri 70

Both **A** and **B** are 300mm deep (from wall to front of unit)

*Dimensions dependant on fire selected.*

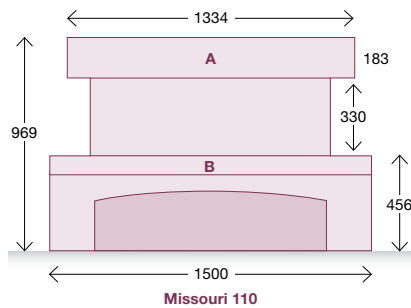

Missouri 110



Missouri 110 Base Unit in White and Midnight Finish





Oregon 150 Base Unit in Midnight with Oak Finished Strips Top Shelf in Midnight Finish



Oregon 150 Base Unit in Midnight with Oak Finished Strips Top Shelf in Light Oak Finish



Oregon 150 Base unit in Midnight with Oak Finished Strips Top Shelf in White

# Oregon *illustrated with the Onyx Avanti fire*

If you are looking for a feature fireplace with a real presence, then the incredibly versatile Oregon is for you! Illustrated with oak veneer timber strips, the base unit, shelf and top can be adapted to suit your requirements.

Other versions of the Oregon design can be seen on the front cover and page 2.

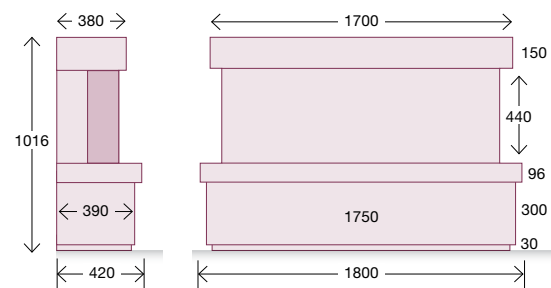

**Oregon 150**

*Dimensions dependant on fire selected.*



NEW - Oak Veneer Timber Slats add a unique touch of class to the Base Unit



HS100 Shelf made to special dimensions in White Finish  
Also shown S60 Display Shelves in White Finish

Introducing shelves into your living space can have a dramatic effect.

Here the inset eReflex 105R has a made-to-measure shelf extending across the front of the chimney breast making a bold statement.

Additional display shelves to the side further enhance the look. All shelves can be manufactured to your exact sizes and in many cases they will be compatible with our Easy-fix system.

# Shelves

HS100 Shelf made to special dimensions:  
Round Edge Oak in a Light Finish  
Also shown HS70 Display Shelves  
in Light Oak Finish



Complement your fireplace with matching Display Shelves – made to suit your individual requirements.

Produced in three thicknesses:

60mm – available in oak finish or painted

70mm – available in solid oak

100mm – available in oak, painted or veneered



# Ripon



Ripon in White and Grey Pearl Finish

For a truly 'integrated' look the Ripon combines a fireplace for the eReflex 85R electric fire with a media centre that would be ideal for your television and Sky boxes etc. The Ripon suite can also be made larger to accommodate the longer eReflex inset electric fires such as the 105R or the 135R and fires from other manufacturers.

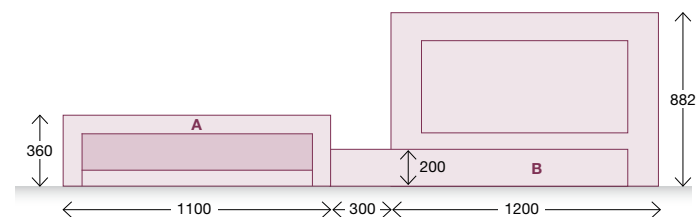

Both A and B are 300mm deep (from wall to front of unit)

Dimensions dependant on fire selected.

# Modern Electric Fireplaces | 3

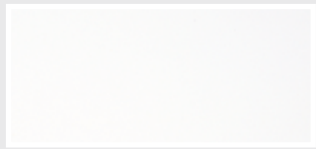

White



Concrete

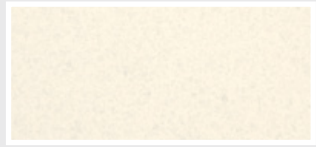

Bianca

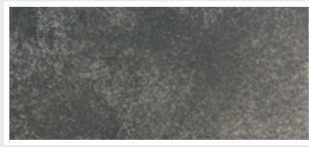

Slate



Mid Grey



Oatmeal

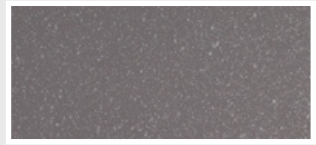

Grey Pearl

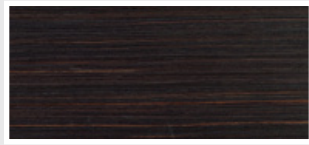

Black Oak

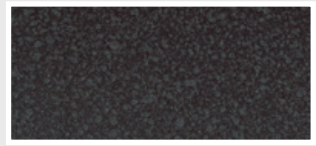

Midnight



Light Oak



Grey Wash



Light/Medium Oak

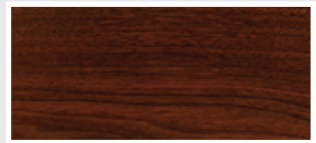

American Walnut

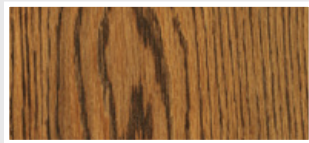

Medium Oak

All painted finishes are applied onto fireplaces made from high-quality medium density fibreboard.

**Light Oak, Black Oak, Grey Washed Oak** and **Walnut** finishes are premium quality veneers applied to high quality medium density fibreboard.

**Light Oak, Light/Medium Oak** and **Medium Oak** are different shades applied to solid oak components.

In addition to the range of modern electric fireplaces shown in this brochure, Focus Fireplaces also supply a large range of other products.

- A stunning choice of over 100 fire surrounds designed for gas, solid fuel and electric
- Furniture ranges created specifically to complement many of the fireplaces
- Beams, shelves and surrounds to fit over stoves
- Roof beam covers

Ask your retailer for the brochures on these other products.



**Focus Fireplaces Limited**  
Unit 27  
The Bull Commercial Centre  
Stockton-on-Forest  
York YO32 9LE

Tel: **01904 400109, 01904 400545**

email: [sales@focusfireplaces.co.uk](mailto:sales@focusfireplaces.co.uk)

[www.focusfireplaces.co.uk](http://www.focusfireplaces.co.uk)



*Focus Fireplaces are continually updating and improving their products. We reserve the right to alter designs, dimensions and specifications of surrounds without notice.*

*All sizes are approximate.*

*Brochure colours may vary from the actual product due to the photographic and printing processes and the variations in grain of solid timbers.*

© Focus Fireplaces Manufacturing 2021