



Electric

Collection



Quality & style is our passion

Introduction

We hope you enjoy browsing through our latest electric fireplace suite brochure. Newman Fireplaces are proud to offer Flamerite electric fires alongside this longstanding British electric fire manufacturer. All electric fires shown are available individually or as a complete fireplace suite. The high quality electric fires with the option of the Newman designed fuel bed are designed and built in Great Britain by Flamerite fires to the highest standard and now we are offering a range of high quality natural stone fireplaces to match, specifically designed to allow installation onto a suitable flat wall without the need for any chimney or wall recess. We believe that a realistic log effect electric fire deserves a realistic fireplace so what better choice is there than one of our high class natural stone fireplaces to compliment.

Our fireplace range is manufactured from high quality limestone and various natural stones with each piece of stone being carefully selected in our own factory to ensure each fireplace when complete is top class, we feel this is essential as you will spend many years sitting and admiring your important purchase and you deserve the very best available from our dedicated manufacturing facility. All of our fireplaces can be made to measure subject to request and there is the option for each fireplace to be made in various natural materials as shown within this brochure. For customers with existing chimneys please see our other conventional fireplace brochures, these fireplace models can be adapted to fit our electric fire range, conversely these could also be adapted to accommodate flat wall installation if required.

Advantages of electric fireplace suites.

- No requirement for a chimney.
- Zero heat loss through chimney as not required.
- Economical installation costs when compared to gas and solid fuel appliances.
- More environmentally friendly as zero combustion from the appliance.
- Healthier internal and external environment when compared to solid fuel stoves.
- Lower maintenance and service costs compared to gas and solid fuel appliances.
- More versatility to the installation position, all that is needed is a suitable and serviceable mains power socket nearby and a suitable flat wall.
- Realistic flame and log effect.
- Versatile control when using the app.
- Very low running costs to the flame effect.
- High efficiency.

Quality & style
is our passion



www.newmanfireplaces.co.uk

Whats what?

Omniglide (Patented)

A tilting glass panel that enhances the flame picture creating infinity and depth encloses the fuel bed and conceals the heater.

OMNIGLIDE®



Smart eControl

Award winning, easy to use iOS & Android app with advanced features to control your fire.

CrystalHD

Low reflective fascia glass. Enhances the superb flame effect even further.



LED Down lights

LED low energy ambient lighting system which can be installed to some fireplace models. Control can be by motion sensor or hand held remote control subject to model.



Our natural stones.

Bella Crème limestone

Type: Natural limestone
Finish: Honed
Colour: Off white
Pattern: Small to medium movement.



Medistone limestone

Type: Natural limestone
Finish: Honed or polished
Colour: Beige
Pattern: Light to heavy movement.

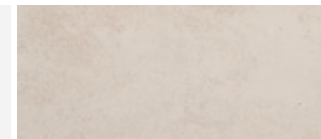

Portuguese veined limestone

Type: Natural Portuguese limestone
Finish: Honed
Colour: Off white
Pattern: Veined. Light to medium movement.

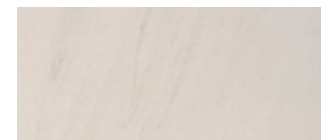

Azul Grey marble

Type: Natural marble
Finish: Honed or polished
Colour: Grey / blue
Pattern: Medium to heavy movement.



Black granite

Type: Natural granite
Finish: Honed or polished
Colour: Black
Pattern: Light to medium (Speckle).

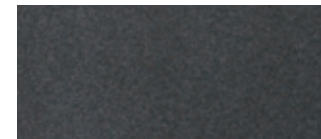

Vulcan granite

Type: Natural granite
Finish: Flamed
Colour: Combination of mottled black, grey, beige & white.
Pattern: Mottled can also contain a silver fleck.



Note: The description and picture of each natural material is just a guide it is not guaranteed as natural material will be subject to variation.

Electric Fires

- All electric fires and down lights must be installed by a suitably qualified and competent electrician to all relevant building regulations, any rules in force and the manufacturer's instructions.
- All products are protected by patents, registered design, copyrights and intellectual property rights. Newman Fireplaces Ltd. and Flamerite Fires Ltd. will protect these rights.
- All specifications are subject to change without prior notice.
- All goods should be inspected for quality and damage before installation, no refunds will be given regarding this after the product is installed.
- The electric fires shown in this brochure have been designed to offer an outstanding simulated log effect that can be enjoyed all year round, the built in fan heaters are not suitable as a primary heat source, although they may provide a secondary heat source to the room the fire is installed, this can vary widely depending on the size of room and how well the room is insulated therefore no guarantees can be made to the effectiveness to the room temperature when the fan heater is used.

Fireplaces

- We pride ourselves with detailed inspection and selection of each and every raw stone block we use and every process thereafter, however stone is a natural material and variation will occur. This will include shading, veining, fossils and crystal markings. This is the beauty of natural stone and sets it apart from a man made counterpart.
- Every effort has been made to show correct colour representation, although no guarantees can be given due to the printing process. Customers are advised to view all products and samples at their fireplace retailer.
- It is strongly recommended that your selected retailer surveys your intended installation site and all relevant items before purchasing any of our products.
- All goods should be inspected for quality and damage before installation, no refunds will be given regarding this after the product is installed.
- All of our products must be installed by a suitably qualified, competent and experienced installer complying with all relevant building regulations and any rules in force and manufacturers instructions.
- Any description used to any product is in the view of the editor only and most not be used as a factual statement.
- Dimensions are approximate.
- Any ancillary item shown in this brochure including ornaments, decorative logs and furnishing etc is not part of any fireplace sale including the electric fire appliance. (The electric fire is included only if the fireplace is purchased as a complete fireplace / electric fire suite).
- We supply only to fireplace retail specialists within the UK. This has the advantage of viewing some of our products usually within close proximity to where you live. Also the dealer can offer professional advice and surveys for your chosen product giving you total piece of mind, a very important part of any fireplace purchase.
- Newman Fireplaces Ltd always strive for continued improvement, therefore designs and products are occasionally altered or discontinued without prior notice (a reserved right). It is advised that you contact your fireplace retailer for advice for any known change before commencing and planning or any associated works for your intended purchase.
- It is advised that when any natural stone fireplace has fully dried after installation, that all surfaces are sealed with a suitable stone sealer. Ask your fireplace dealer for advice.



Quality & style
is our passion



- Main picture: Citrin EL Deluxe manufactured in Bella Crème limestone, incorporating a honed black granite skirt and our Inglebeam Telford legs in light oak finish.
- Inset picture: Citrin EL Standard manufactured in Bella Crème limestone with Vulcan granite legs and skirt.
- Lower skirt options: Honed Azul Grey marble, Bella Crème limestone, Vulcan granite, honed black granite or polished black granite.
- Leg Options : Honed black granite, polished black Granite, Vulcan granite, Azul grey marble or matching Bella Crème limestone as sample swatches shown on page 3. Telford legs available for both models.
- Telford legs: Available in light and dark oak finish.
- Flat wall fix.
- No chimney required.

Optional extras for the Citrin EL Deluxe and Citrin EL Standard fireplace models:

- Header LED down lights for both fireplace models. • Made to measure service available for both fireplace models.
- Hearth LED down lights for the Citrin EL Standard model.
- Both fireplace models can be manufactured entirely or with various combinations of our natural limestones as sample swatch shown on page 3.

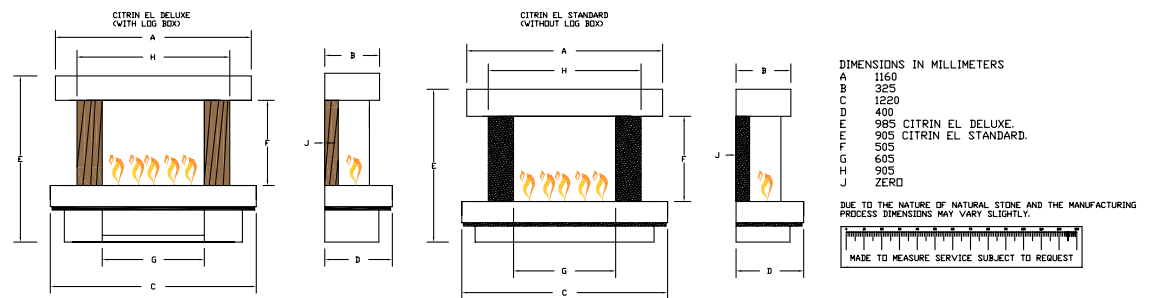

Glazer 600 electric fire

- Panoramic 3 sided glass burn area.
- Realistic Newman high definition log effect only available with our fires.
- Thermostatically controlled 750W/1500W.
- Omniglide patented 2 position front glass with dimmable LED flame effect.
- **Smart eControl app.** Easy to use iOS & Android app with advanced features (download required).
 Allows use of the advanced features, which include a thermostatically controlled 1.5kw heater, two dimmers, flicker control and a seven day timer
- Manual keypad. • Fire can be purchased separately.
- CrystalHD low reflective fascia glass.
- The low energy LED flame effect can be enjoyed with or without heat.
- Visible burn area after fitting. W 600mm x H 500mm x D 180 (3 sided glass option).
- Appliance dimensions as shown. W 610mm x H 725mm x D 265mm.



Citrin EL Standard

Full size picture on back cover



Mertola EL fireplace

- Manufactured in natural Portuguese limestone.
- Flat wall fix. • No chimney required.

Optional extras:

- Made to measure service available.
- Manufactured in any natural limestone or a combination of natural limestones as shown on page 3.

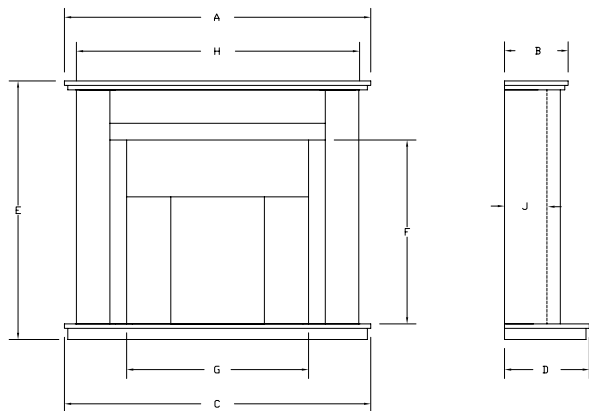

DIMENSIONS 48".		DIMENSIONS 54".	
A	1220	A	1372
B	285	B	285
C	1220	C	1372
D	380	D	380
E	1110	E	1160
F	775	F	825
G	663	G	815
H	1113	H	1265
J	190	J	190

DUE TO THE NATURE OF NATURAL STONE AND THE MANUFACTURING PROCESS DIMENSIONS MAY VARY SLIGHTLY.



IMPORTANT NOTE.
THE FIRE OPENING SLIPS CAN BE MODIFIED TO ACCOMMODATE THE FOLLOWING ELECTRIC FIRES.
48" MERTOLA EL: GOTHAM 400 STANDARD OR THE GOTHAM 600 AS AN OPTIONAL EXTRA.
54" MERTOLA EL: GOTHAM 400 AS STANDARD, OR THE GOTHAM 600 OR 750 AS AN OPTIONAL EXTRA.

Gotham 400 electric fire

- Realistic log effect only available with our fires.
- Thermostatically controlled 750W/1500W concealed fan heater.
- Omniglide patented 2 position front glass with dimmable LED flame effect when using app.
- Also available with Remote control / Manual control (high level switches).
- Glass fronted as standard.

- **Smart eControl app.** Easy to use iOS & Android app with advanced features (download required).



Allows use of the advanced features, which include a thermostatically controlled 1.5kw heater, two dimmers, flicker control and a seven day timer



- Main picture shows: 48" Mertola EL.
- Shown with the Lunar fire front in Nickel finish.
- Shown with the Solar fire trim in Nickel finish.
- Optional fire trims and fire front available. (See inset pictures)
- Fire can be purchased separately.
- Glass dimensions. W 400mm x H 310mm.
- Appliance external dimensions. W 495mm x H 560mm x D 230mm.
- Appliance inst dimensions. W 405mm x H 560mm x D 160mm.



Lunar fire front in polished stainless steel.
Odyssey fire trim in polished stainless steel
with brushed stainless steel relief.



Lunar fire front in brushed stainless steel.
Solar fire trim in brushed stainless steel.



Electric Collection

*Quality & style
is our passion*



*Quality & style
is our passion*



Europa EL fireplace

- Manufactured in a combination of luxurious Bella Crème, Medistone and black granite natural stones.
- Available with either honed or polished natural Medistone upper plinth.
- Flat wall fix.
- No chimney required.

Optional extras:

- Plinth and header remote controlled LED down lights, features standard white light and on / off control.
- Made to measure service available.
- Fireplace can be manufactured entirely or with any combination of our natural limestone's as shown on page 3.

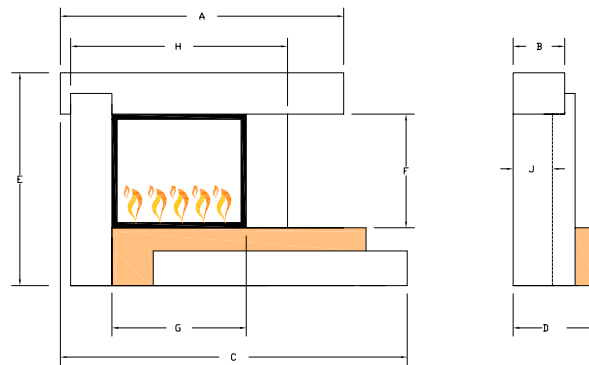

DIMENSIONS IN MILLIMETERS

A	1372
B	250
C	1680
D	400
E	1030
F	550
G	650
H	1050
J	190

DUE TO THE NATURE OF NATURAL STONE AND THE MANUFACTURING PROCESS DIMENSIONS MAY VARY SLIGHTLY.



Gotham 600 electric fire

- Realistic Newman high definition log effect only available with our fires.
- Thermostatically controlled 750W/1500W.
- Omniglide patented 2 position front glass with dimmable LED flame effect.
- **Smart eControl app.** Easy to use iOS & Android app with advanced features (download required).
 Allows use of the advanced features, which include a thermostatically controlled 1.5kw heater, two dimmers, flicker control and a seven day timer

- Manual keypad.
- Fire can be purchased separately.
- Glass dimensions. W 604mm x H 500mm.
- Appliance dimensions. W 700mm x H 730mm x D 160mm.



Calypso EL fireplace

- Manufactured in a combination of luxurious Bella Crème, Medistone and black granite natural stones.
- Flat wall fix.
- No chimney required.

Optional extras:

- Optional remote controlled LED down lights to the centre plinth, features standard white light and on / off mode.
- Made to measure service available.
- Fireplace can be manufactured entirely or with any combination of our natural limestone's as shown on page 3.

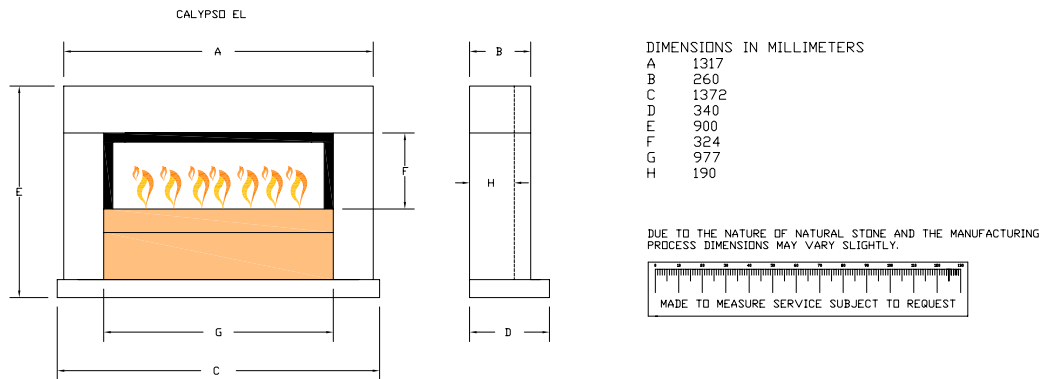

Gotham 900 electric fire

- Realistic Newman high definition log effect only available with our fires.
- Thermostatically controlled 750W/1500W.
- Omniglide patented 2 position front glass with dimmable LED flame effect.
- **Smart eControl app.** Easy to use iOS & Android app with advanced features (download required).
Allows use of the advanced features, which include a thermostatically controlled 1.5kw heater, two dimmers, flicker control and a seven day timer



- Manual keypad.
- Fire can be purchased separately.
- Glass dimensions. W 904mm x H 280mm.
- Appliance dimensions. W 1000mm x H 500mm x D 160mm.



Quality & style
is our passion





*Quality & style
is our passion*

Alcudia EL fireplace

- Luxurious Bella Crème natural limestone.
- Flat wall fix.
- No chimney required.

Optional extras:

- Made to measure service available.
- Fireplace can be manufactured entirely or with any combination of our natural limestone's as shown on page 3.

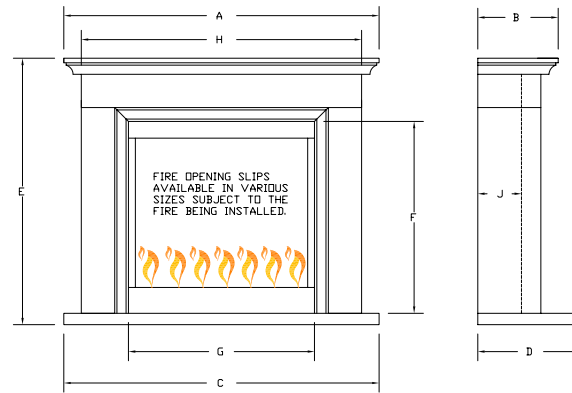

54" (1372) WIDE VERSION		48" (1220) WIDE VERSION	
DIMENSIONS IN MILLIMETERS		DIMENSIONS IN MILLIMETERS	
A	1372	A	1220
B	350	B	285
C	1372	C	1220
D	460	D	410
E	1160	E	1085
F	835	F	802
G	810	G	775
H	1220	H	1115
J	190	J	190

DUE TO THE NATURE OF NATURAL STONE AND THE MANUFACTURING PROCESS DIMENSIONS MAY VARY SLIGHTLY.



Gotham 750 electric fire

- Realistic Newman high definition log effect only available with our fires.
- Thermostatically controlled 750W/1500W.
- Omniglide patented 2 position front glass with dimmable LED flame effect.

- **Smart eControl app.** Easy to use iOS & Android app with advanced features (download required).



Allows use of the advanced features, which include a thermostatically controlled 1.5kw heater, two dimmers, flicker control and a seven day timer

- Manual keypad.
- Fire can be purchased separately.
- Glass dimensions. W 754mm x H 650mm.
- Appliance dimensions. W 850mm x H 875mm x D 160mm.



Merlin EL fireplace

- Manufactured in a combination of luxurious Bella Crème, Medistone and marble inlay natural stones.
- Flat wall fix.
- No chimney required.

Optional extras:

- Hearth and leg remote controlled LED ambient lights featuring variable colour and dimming control.
- Made to measure service available.
- Fireplace can be manufactured entirely or with any combination of our natural limestone's as shown on page 3.

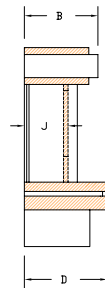
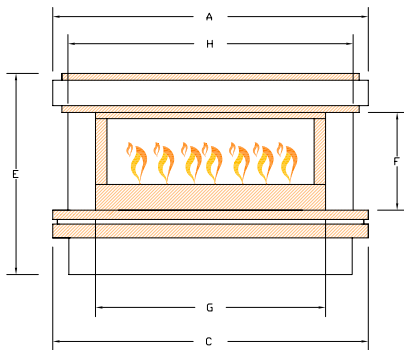

DIMENSIONS IN MILLIMETERS

A	1372
B	320
C	1372
D	360
E	875
F	425
G	1000
H	1240
J	190

DUE TO THE NATURE OF NATURAL STONE AND THE MANUFACTURING PROCESS DIMENSIONS MAY VARY SLIGHTLY.



Gotham 900 electric fire

- Realistic Newman high definition log effect only available with our fires.
- Thermostatically controlled 750W/1500W.
- Omniglide patented 2 position front glass with dimmable LED flame effect.

- **Smart eControl app.** Easy to use iOS & Android app with advanced features (download required).



Allows use of the advanced features, which include a thermostatically controlled 1.5kw heater, two dimmers, flicker control and a seven day timer

- Manual keypad.
- Fire can be purchased separately.
- Glass dimensions. W 904mm x H 280mm.
- Appliance dimensions. W 1000mm x H 500mm x D 160mm.



Electric Collection





*Quality & style
is our passion*



Quality & style is our passion



Dimension 3D EL fireplace

- Manufactured in Luxurious Bella Crème limestone including Azul Grey natural marble lower plinth inlay.
- Selection of lower plinth inlay natural stones: Azul Grey, Bella Crème or black granite natural stones.
- Flat wall fix.
- No chimney required.

Optional extras:

- Optional remote controlled upper plinth LED down lights, featuring variable colour and dimming control.
- Made to measure service available.
- Fireplace can be manufactured entirely or with any combination of our natural limestone's as shown on page 3.

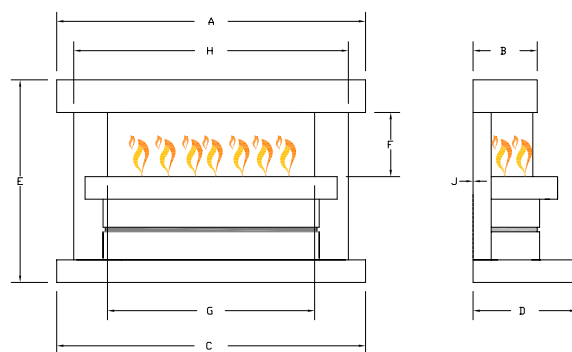

DIMENSIONS IN MILLIMETERS

A	1372
B	285
C	1372
D	460
E	900
F	285
G	920
H	1220
J	ZERO

DUE TO THE NATURE OF NATURAL STONE AND THE MANUFACTURING PROCESS DIMENSIONS MAY VARY SLIGHTLY.



Glazer 900 electric fire

- Panoramic 3 sided glass burn area.
- Realistic Newman high definition log effect only available with our fires.
- Thermostatically controlled 750W/1500W.
- Omniglide patented 2 position front glass with dimmable LED flame effect.

- **Smart eControl app.** Easy to use iOS & Android app with advanced features (download required).



Allows use of the advanced features, which include a thermostatically controlled 1.5kw heater, two dimmers, flicker control and a seven day timer



- Manual keypad.
- CrystalHD low reflective fascia glass.
- Fire can be purchased separately.
- The low energy LED flame effect can be enjoyed with or without heat.
- Visible burn area W 900mm H 285mm D 185m.
- Appliance dimensions as shown. W 910mm x H 505mm x D 265mm



Venice EL fireplace

- Manufactured in natural Portuguese veined limestone.
- Flat wall fix.
- No chimney required.

Optional extras:

- Made to measure service available.
- Fireplace can be manufactured entirely or with any combination of our natural limestone's as shown on page 3.

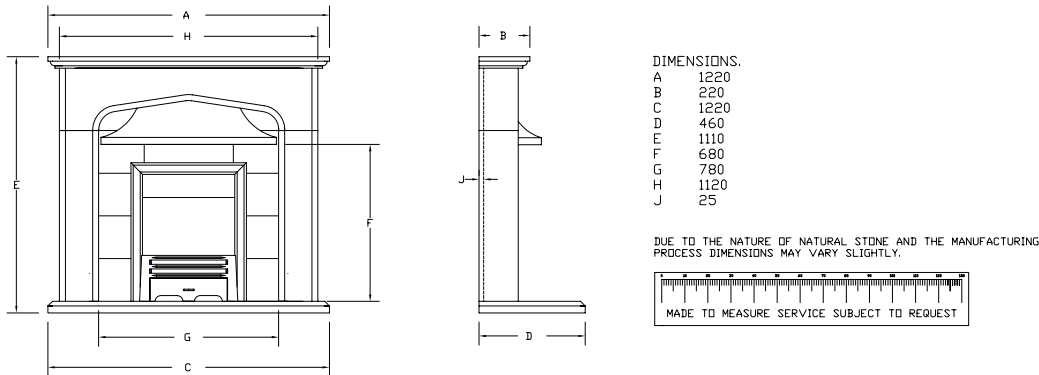

Regan 16 electric fire

- Manual or remote control with LED flame effect.
- Concealed 1000W/2000W thermostatically controlled fan heater.
- Choice of 3 fire fronts.
- Choice of fuel effects: Coal, white pebbles or glass beads as standard with Newman high definition logs as an optional extra.
- Shown with the Cameo fire trim in polished stainless steel finish.
- Shown with the Rhapsody fire front in chrome and black finish.
- Flat wall spacer available as an optional extra.
- Appliance external dimensions. W 485mm x H 600mm x D 200mm.
- Appliance inset dimensions. W 385mm x H 550mm x D 40mm



Eclipse Fire Front



Melody Fire Front



Quality & style
is our passion





Issue 24

Dealer Sticker

© 2020 Newman Fireplaces Ltd

E&OE



Fireplace shown: Citrin Standard

Quality & style is our passion